

FIZI BALL COLLECTION

TALL TABLE LAMP

UL SPECIFICATION SHEET

NORTH AMERICA



ARTICOLO

FIZI BALL COLLECTION

TALL TABLE LAMP

UL SPECIFICATION SHEET

NORTH AMERICA

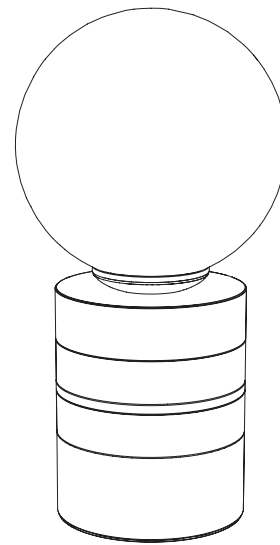
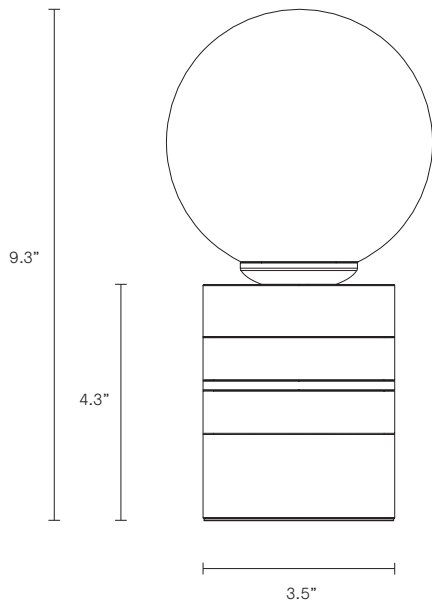
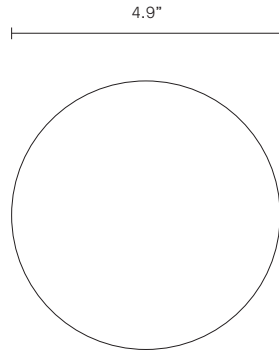

FI_TTL_S_UL_20V1

ABOUT FIZI

Effervescent yet luxuriously artisanal, Fizi is a celebration of 'the art of light'. The Fizi ball seems to burst with tiny bubbles glinting below the surface.

When lit, Fizi throws superb patterns and movement onto the surrounding walls, reflecting the unique material identity of mouthblown glass.

Fizi balls are removable for easy cleaning.

Fizi available in wall sconce and pendant. Custom multi drops upon request.

LEAD TIME

8 - 10 weeks

LIGHT SOURCE

120V G9 3.5W LED bipin
2700k warm white
350 lumens

WEIGHT

11.5 lb

CERTIFICATION

US/ETL/CA

WARRANTY

3 years

FITTING DESIGN

Short
Tall (shown)

FITTING FINISH

Brass
Mid Bronze (shown)
Satin Nickel

STONE FINISH

Marble
Travertine (shown)

FLEX CORD COLOURS

White
Black
Ivory (shown)

