

TRILOGY COLLECTION  
TRILOGY WALL SCONCE

UL SPECIFICATION SHEET  
NORTH AMERICA



ARTICOLO

# TRILOGY COLLECTION

## TRILOGY WALL SCONCE

# UL SPECIFICATION SHEET

NORTH AMERICA

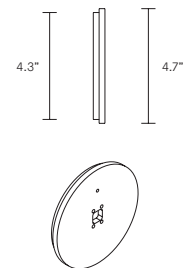
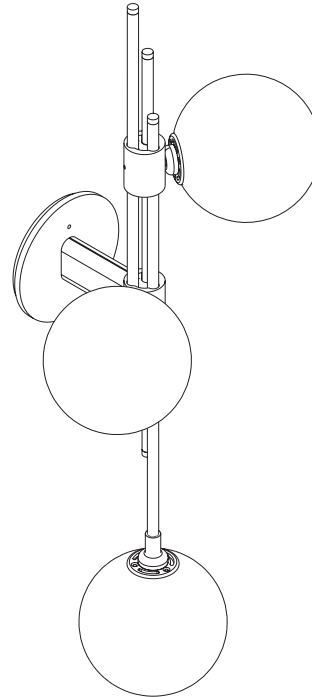
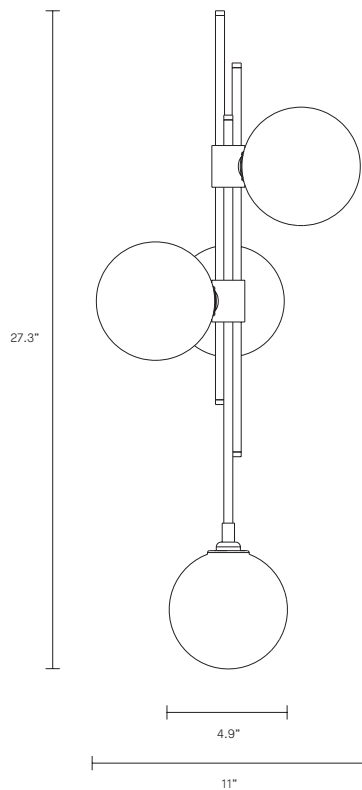
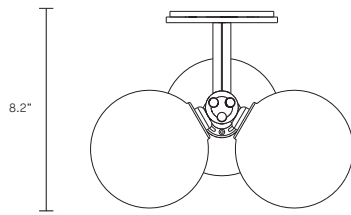

TR\_WS\_ST\_UL\_20V1

### ABOUT TRILOGY

Trilogy collection exemplifies contemporary sophistication of yesteryear drawing from art deco imaginings with staggered rods and jewel like cuff detailing and a trio of mouthblown orbs.

Available in wall sconce and pendant options.

### LEAD TIME

8 - 10 weeks

### LIGHT SOURCE

3 x 12V G4 2W LED bipin  
3000K warm white  
630 total lumen output  
Dimmable (Luxtron/Diva/CL)  
Globes included

### INSTALLATION

Supplied with external driver  
and mounting plate to fit  
4.0/3.5 Jbox

### CUSTOMISATION

Variations to rod length can  
be specified at time of order  
placement

### WEIGHT

15.5 lb

### FITTING FINISHES

Brass (shown)  
Mid Bronze  
Satin Nickel

### SHADE COLOURS

Fizi (shown)  
Scandi  
Spoti Black  
Spoti White  
Drunken Emerald

### CERTIFICATION

US/ETL/CA

### WARRANTY

3 years