

SLIM COLLECTION

PENDANT

SPECIFICATION SHEET

AUSTRALIA / INTERNATIONAL



ARTICOLO

SLIM COLLECTION

PENDANT

SPECIFICATION SHEET

AUSTRALIA / INTERNATIONAL

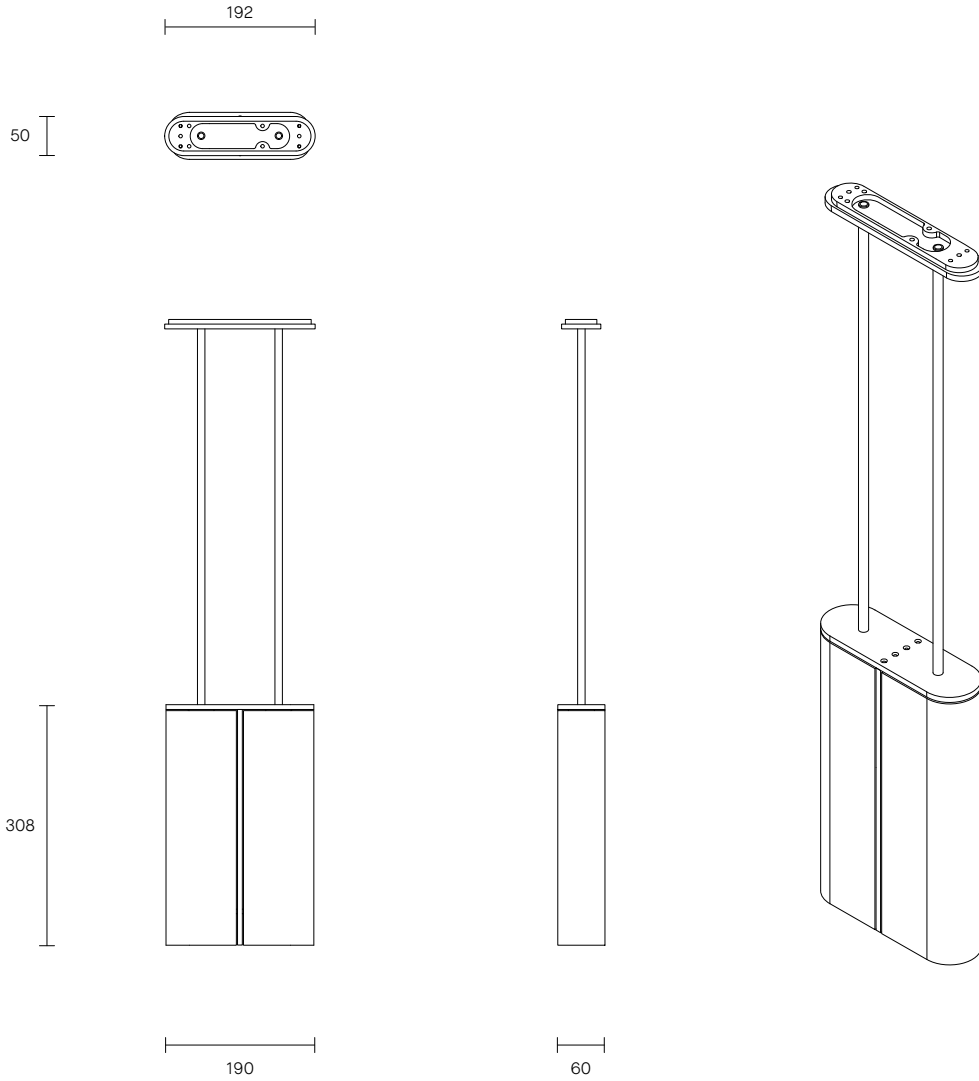

SL_P_AU_20V3

ABOUT SLIM

Inspired by the sophisticated high life depicted in Slim Aaron's famed Palm Springs photography, 'Slim' reinterprets mid-century Californian modernism in architectural form and refined simplicity.

The arresting restraint of the Slim evokes effortless glamour. Its light source is housed within an elongated arch of mouth blown glass and framed in hand finished metalwork by local artisan's. When paired back to back, the arches of Slim transform into a 'Double Pendant', inlaid with brass and mid bronze, and crowned with a striking double suspension.

LEAD TIME

6 - 8 weeks

LIGHT SOURCE

2 x 12VDC 500mA CC LED board
2700k warm white
860 total lumen output
Globes included

INSTALLATION

Supplied with external driver

CUSTOMISATION

Standard drop length up to 1200mm. Additional charge will apply for longer drop lengths, price upon request. Variations to rod length can be specified at time of order placement

WEIGHT

5kg

FITTING FINISHES

Brass
Mid Bronze (shown)
Satin Nickel

SHADE COLOURS

White Frost
White Gloss
Grey (shown)

CERTIFICATION

CE/AU

WARRANTY

3 years